

## 20MVL VERTICAL PERSONNEL LIFTS

### Platform

- 0.66 m x 1.25 m (W x L) Slide bar entry extendable platform
- Quick-change platform mounts
- Safety interlocked controls
- Point & Go® fully proportional drive/steer single joystick control
- Joystick enable for lift and drive
- Variable speed elevation control
- Load sensing system
- Lanyard attachment anchor

### Power & Transmission

- 2 x Sealed 12V,100 A/Hr maintenance-free AGM batteries
- Automatic 5 hour battery charger
- On-board diagnostics
- Automatic power-off battery saver control
- Battery discharge indicator (located on platform and base)
- Direct electric two wheel drive
- Heavy duty planetary gear hubs
- Non mark tyres and casters
- Brake release
- AC power cable to platform
- Non-marking tyres

### Functional Equipment & Accessories

- Low maintenance anodised aluminium mast
- Pothole Protection System (PHP)
- Manual Descent
- Tilt light and alarm
- Key lock main power switch
- Hour meter
- Transportation tie-down lugs
- Fork truck pockets
- Horn
- Amber strobe light

### Available Options

- 0.71 m x 1.22 m (W x L)  
Stock picking platform- front and side entry
- Multi-position hand rails
- 0.56 m x 0.64 m (W x L)  
Narrow slide bar entry platform
- 0.69 m x 0.58 m (W x L) Platform with  
0.69 m x 0.58 m material tray
- Programmable 4 digit security lock
- Lifting eye for crane hook
- 4 x Sealed 6V, 210A/hr maintenance free  
AGM batteries
- Travel alarm
- Tool tray (0.20 m x 0.46 m x 0.13 m)
- Fluorescent tube caddy



## 20MVL VERTICAL PERSONNEL LIFTS

Platform Height	5.98 m
Working Height	7.98 m
Max Drive Height	5.98 m
Stowed Height	1.98 m
Platform Entry Height	0.46 m
Platform Entry Height Stock Picking Platform	0.43 m
Platform Capacity - Side Entry Platform	115 kg
Material Tray Capacity	45 kg
Platform Capacity - Stockpicking Platform	160 kg
Platform Capacity - Narrow Platform	160 kg
Platform Capacity - Extension Platform	160 kg
Platform Size - Side Entry with Material Tray	0.69 m x 0.58 m
Material Tray Size (W x L)	0.69 m x 0.58 m
Platform Size - Stockpicking Platform (W x L)	0.63 m x 0.71 m
Platform Size - Narrow Platform (W x L)	0.56 m x 0.63 m
Platform Size - Extension Platform Retracted (W x L)	0.66 m x 0.66 m
Platform Size - Extension Platform Extended (W x L)	0.66 m x 1.25 m
Vehicle Length - Extension Platform Retracted	1.36 m
Vehicle Length - Stock Picking Platform	1.88 m
Vehicle Length - All other Platforms	1.36 m
Vehicle Width - Chassis Width	0.75 m
Vehicle Width - Extension Platform	0.80 m
Vehicle Width - Stock Picking Platform	0.80 m
Vehicle Width - All Other Platforms	0.75 m
Machine weight - All Other Platforms <sup>1</sup>	1,060 kg
Machine weight - Extension Platform <sup>1</sup>	1,090 kg
Machine weight - Stock Picking Platform <sup>1</sup>	1,110 kg
Maximum Ground Bearing Pressure Front Casters	19.50 kg/cm <sup>2</sup>
Maximum Ground Bearing Pressure Rear Wheels	9.21 kg/cm <sup>2</sup>
Drive Maximum Speed - Platform Lowered	5.4 km/h
Drive Maximum Speed - Platform Elevated	0.8 km/h
Turning Radius	Zero
Gradeability	20%
Ground Clearance	5 cm
Wheel Diameter - Rear Drive & Steer Wheels	32 cm x 10 cm
Wheel Diameter - Front Castor Wheels	20 cm x 6 cm
Tyre Material	Non-marking
Batteries	Maintenance-Free 100 A/hr AGM (x 2)

<sup>1</sup> Certain options or country standards may increase weight and/or dimensions.

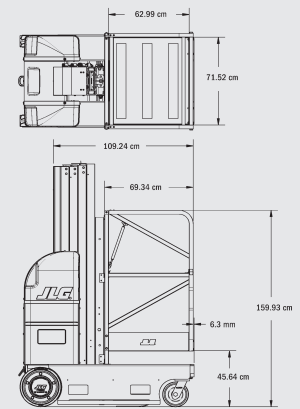

STANDARD

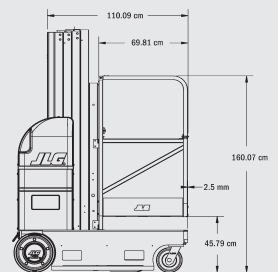
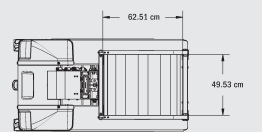

NARROW

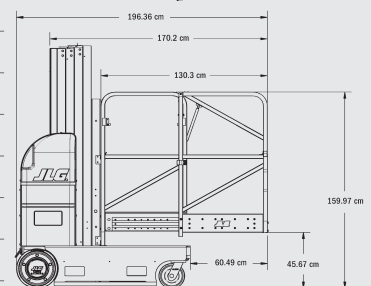
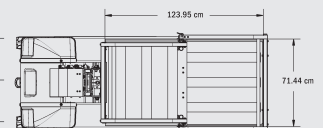

EXTENDED

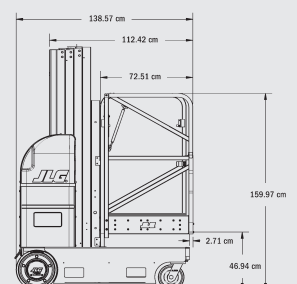
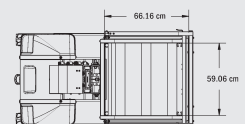

RETRACTED

**JLG Industries, Inc. is a leading designer and manufacturer of access equipment and complementary services and attachments.**

JLG has manufacturing facilities in the United States, France, Romania, China and Belgium. Customers throughout Europe, Scandinavia, Africa and the Middle East benefit from a network of dedicated sales and service operations designed to deliver the highest levels of support.

**JLG is an Oshkosh Corporation company.**

[www.jlgeurope.com](http://www.jlgeurope.com)

JLG is continually researching and developing products and reserves the right to make modifications without prior notice. All data in this document is indicative. Certain options or country standards will increase weight. Specifications may change to meet country standards or with the addition of optional equipment.